

SUPLEMENTOS DE FALLEBA
SUPPLEMENTS FOR GEAR
SUPPLÉMENTS D'ESPAGNOLETTE

HS_SUP_1 / HS_SUP_234 / HS_SUP_5

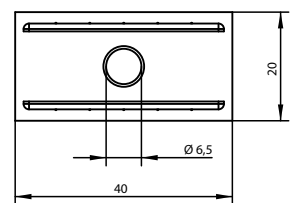

Kit (1).

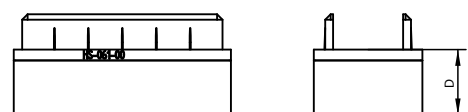
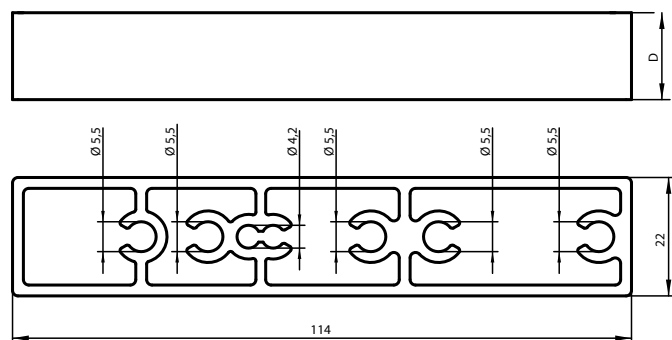
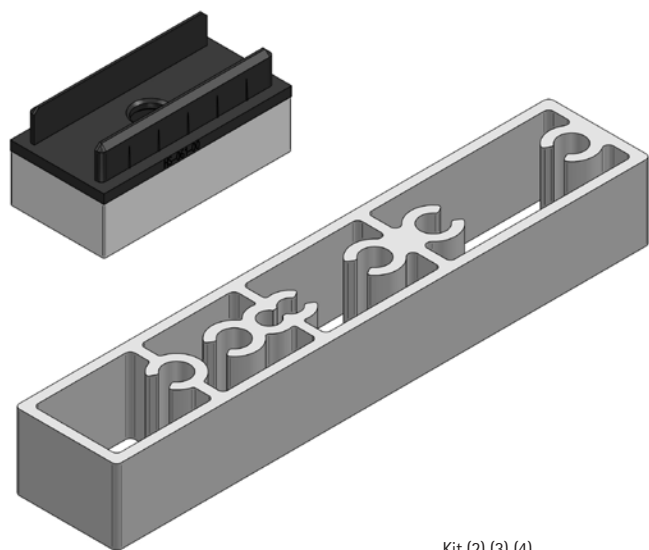
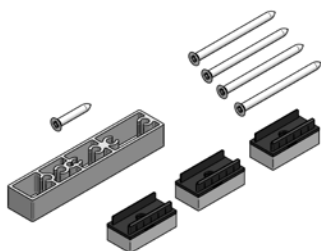

Kit (2) (3) (4).

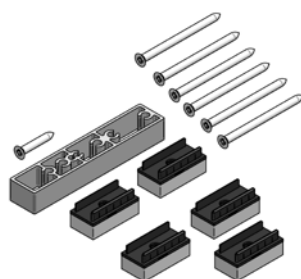

Kit (5).

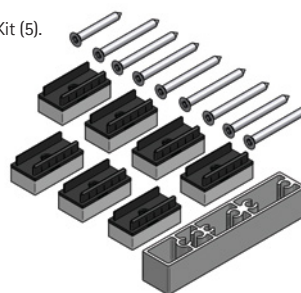

DESCRIPCIÓN	DESCRIPTION	DESCRIPTION
Suplementos de falleba para herraje de corredera-elevable.	Gear supplements for lift and slide fitting.	Suppléments d'espagnolette pour ferrure de coulissant à levage.
CARACTERÍSTICAS TÉCNICAS	TECHNICAL FEATURES	CARACTÉRISTIQUES TECHNIQUES
<p>Utilizable en herrajes de corredera-elavable.</p> <p>Suplemento inferior: perfil de aluminio, cortado a medida según perfil de hoja.</p> <p>Medidas: En stock medidas más habituales.</p> <p>Possibilidad de fabricar, bajo pedido a cualquier medida con un plazo de entrega inmediato.</p> <p>Suplemento de falleba: conjunto de perfil de aluminio cortado a medida y piezas de poliamida.</p> <p>Facilita la colocación de la falleba.</p> <p>Suplemento inferior: fijación directa a carro con tornillería inox.</p> <p>Suplemento falleba: fijación mecánica directa a falleba.</p>	<p>May be used in lift and slide fittings.</p> <p>Bottom supplement: aluminium profile, custom-cut according to sash profile.</p> <p>Dimensions: Most common dimensions available in stock.</p> <p>Any measurement may be manufactured upon demand and supplied immediately.</p> <p>Gear supplement: custom-cut aluminium profile and polyamide parts set.</p> <p>Facilitates installation of the gear.</p> <p>Lower supplement: direct fastening to pulley with stainless steel screws.</p> <p>Gear supplement: mechanical fastening directly to gear.</p>	<p>Utilisable sur ferrures de coulissant à levage.</p> <p>Supplément inférieur: profil en aluminium, découpé sur mesure selon le profil du vantail.</p> <p>Mesures: en stock, les mesures les plus habituelles.</p> <p>Possibilité de fabriquer, sur commande, n'importe quelle mesure dans les délais de livraison les plus brefs.</p> <p>Suppléments d'espagnolette : ensemble de profil en aluminium découpé sur mesure et pièces en polyamide.</p> <p>Pose de l'espagnolette facilitée.</p> <p>Supplément inférieur: fixation directe au galet avec visserie en inox.</p> <p>Supplément espagnolette: fixation mécanique directe sur l'espagnolette.</p>
MATERIALES / MATERIALS / MATÉRIAUX	ATRIBUTOS / FEATURES / ATTRIBUTS	TRATAMIENTOS / TREATMENTS / TRAITEMENTS
<p>Piezas de plástico Plastic pieces Pièces de plastique</p> <p>PO</p> <p>Perfiles extrusión Extruded profiles Profils d'extrusion</p> <p>AL</p> <p>Tornillería Screws Vis</p> <p>INOX</p>	<p> Montaje rápido Quick assembly Montage rapide</p>	<p> Vibrado Vibrated Vibré</p> <p> Desengrase Degreasing Dégraissage</p>
ACABADOS / FINISHINGS / FINITIONS	APERTURAS / OPENING / OUVERTURES	PRESENTACIÓN / PRESENTATION / PRÉSENTATION
<p>⊗</p>		<p>BOLSAS DE 1 UNIDAD Kit de suplementos y tornillería embolsados unitariamente.</p> <p>1 UNITS PACKAGES Supplement kit and screws in single unit packaging.</p> <p>EMBALAGES DE 1 UNITÉ Kit disponible en supplément et visserie emballée à l'unité</p>